

User Manual



Rider 460

WARNING

Always consult your physician before you begin any training. Please read the details in Warranty and Safety information guide in the package.

Australian Consumer Law

Our goods come with guarantees that can not be excluded under the New Zealand and Australian Consumer Laws. You are entitled to a replacement or refund for a major failure and compensation for any other reasonably foreseeable loss or damage. You are also entitled to have the goods repaired or replaced if the goods fail to be of acceptable quality and the failure does not amount to a major failure.

Video Tutorial

For a step-by-step demonstration of device and Bryton Active app, please scan the QR code below to check out Bryton Tutorial Videos.



<http://www.youtube.com/c/BrytonActive>

Getting Started

This section will guide you through basic preparations before the first use with your Rider 460.

Initial Setup

1. Download Bryton Active app on your phone.

2. Turn on your Rider 460.



3. After logging into the app, add the Rider 460 to your account.

4. Set up your profile, preference settings, and data page grid via the app before your first ride.

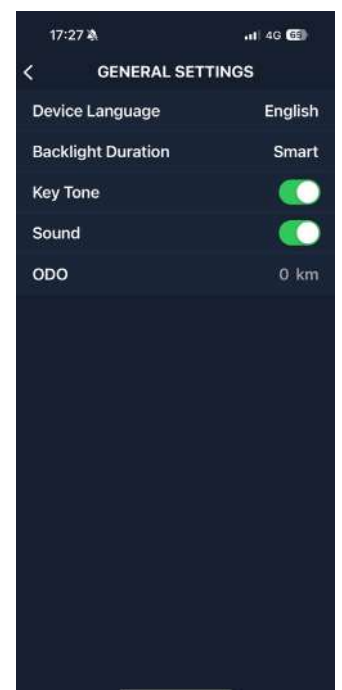
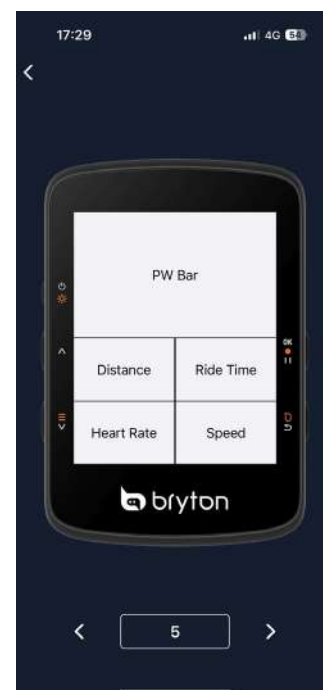
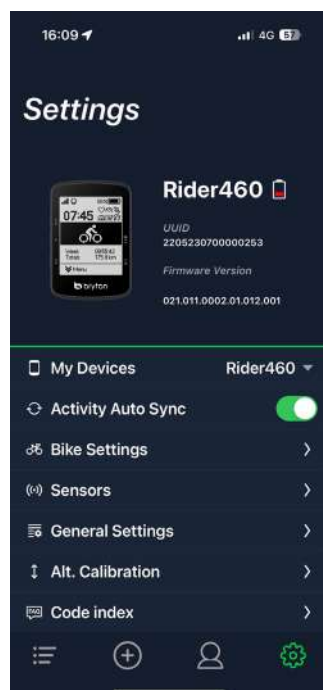
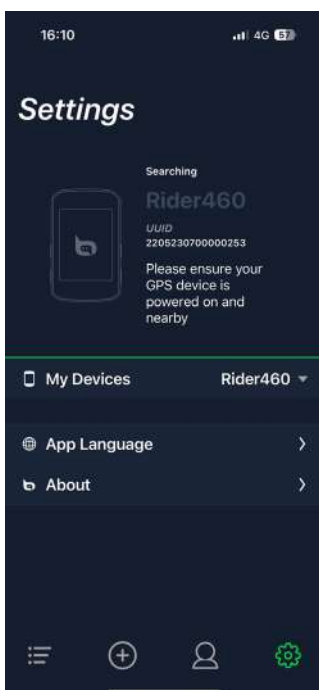

Rider 460 Key Functions



A. Power/Backlight() :

Press to turn the device on.

Press to turn on/off the backlight while the device is on.

Long Press to turn the device off.

B. Up () :

Press to scroll up the data screens and the options in Menu.

C. Down/Menu() :

Press to scroll down the data screens and the options in the menu.

Long press to enter the menu.

D. OK/Record/Pause ():

In Menu, press to enter submenu or confirm a selection.

In data page, press to start recording.

When recording, press to manually pause.

E. Lap/Back ():

In Menu, press to return to the previous page or cancel an operation.

When recording, press to mark the lap.

Reboot Rider

Press (^ / ≡ v / OK ● || / D →) at the same time to reboot the device.

Accessories

The Rider 460 E SKU includes the following accessories:

USB Cable



Bike Mount



Safety Landyard



Optional Item :(Include in D Sku)

Smart Heart Rate Monitor



Smart Cadence Sensor



Quick Menu

Long press ≡ v to access the Quick Menu while recording!
Quick Menu provides easy access to key features during your ride, including the following:

1. Current time
2. Sensor status
3. Smart notification
4. Route
5. Workout
6. Smart training
7. Menu



Status Icons

	GPS Signal		No Signal		GPS Off		Recording
	Phone Connected		Current Climb		Pause		Destination
	LiveTrack Activated		Point North		Scale (Alt. Chart)		Control (Trainer Control)
	Battery		My Location (Map)		Altitude Gain		Sensor Status On
	Menu		My Location (Alt. Chart)		Distance		Sensor Status Off

Step 1: Charge your Rider 460

Charge the Rider 460 battery for at least 4 hours. Unplug the device when it is fully charged. You may see a white screen when the battery is really low. Keep the device plugged in until properly charged. The temperature suitable for charging battery is 0°C ~ 40°C. Beyond this temperature range, charging will be terminated and the device will draw power from battery.

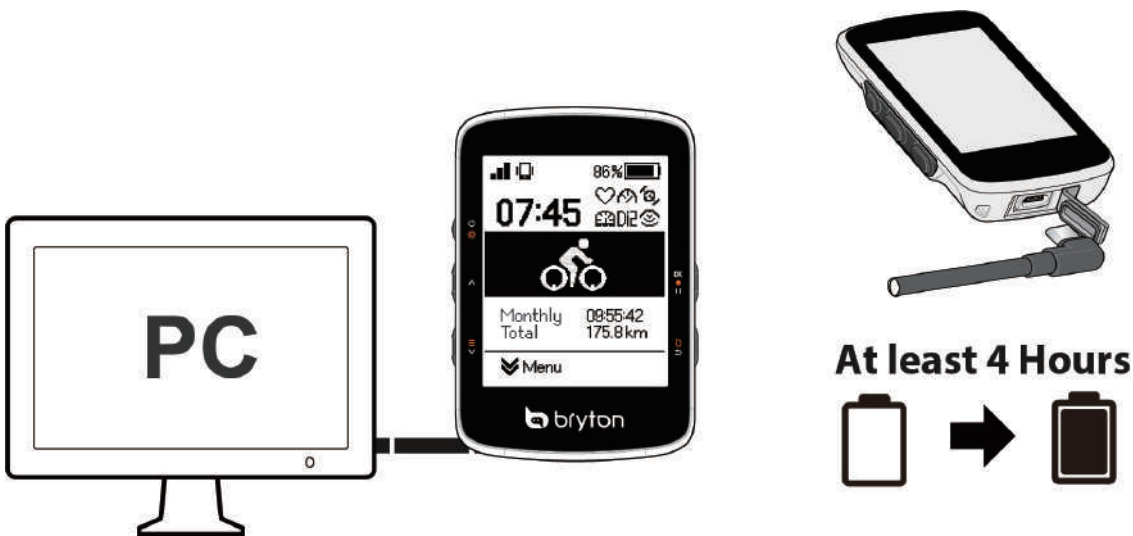

Step 2: Turn On Rider 460

Press to turn on the device.

Step 3: Initial Setup

When powering on the Rider 460 for the first time, follow the instructions to complete setup.

1. Select the display language.
2. Choose the units of measurement.
3. Download Bryton Active app and pair the Rider 460 with your smartphone.





Language	Unit	Bryton Active App	86%
English	KM, KG, °C	 <p>Download the Bryton Active app to set up the device before starting ride.</p>	07:45
Deutsch	MI, LB, °F		Week
Francais	You can customize the unit preferences further within the system settings.		Totals
Italiano			09:55:42
Español			175.8 km

Menu





Step 4: Acquire Satellite Signals

Once the Rider 460 is turned on, it will automatically search for satellite signals.

It may take 30 to 60 seconds to acquire signals for first time use.

- The GPS signal icon ( / ) appears when GPS is fixed.
- If GPS signal is not fixed, a  icon appears on the screen.
- If GPS function is disabled, a  icon shows on the screen.

Please avoid obstructed environments since they might affect GPS reception

				
Tunnels	Inside rooms, building, or underground	Under water	High-voltage wires or television towers	Construction sites and heavy traffic

Step 5: Ride with Rider 460



Ride Time Distance
05:01 **90.8** ^K_m
Avg Speed Alt. Gain
18.1 ^K_m_h **1236** _m

Resume Ride







Save Ride

Menu

Discard Ride

After the “Satellite Acquired” message pops up, enter cycling page and enjoy your ride in free cycling mode.

Start an exercise and record your data:

1. Select “” on the home page to turn on data pages.
2. In cycling mode, press **OK**  to **Start Ride**, While recording press **OK**  to pause manually.
3. Choose **Save Ride** the result to end riding.
4. Choose  to go to the meter page to see your cycling data. Then press  to go back to the previous page.
5. Choose **OK**  to continue recording.
6. Rider 460 supports resume recording when the ride is interrupted. You can turn off the computer to save battery when taking a break and turn it back on to resume recording.

Step 6: Share Your Records

Connect Rider 460 to PC

- a. Connect Rider 460 to PC by using Bryton’s original USB cable.
- b. The folder will pop up automatically or find the “Bryton” disk in the computer.

Share Your Tracks to Brytonactive.com

1. Sign up on Brytonactive.com

- a. Go to <https://active.brytonsport.com>.
- b. Use your Bryton Actgive account to log in or Sign up for a new account

2. Connect to PC

Turn on your Rider 460 and connect it to a computer by USB cable.

3. Share Your Records

- a. Click “+” in the right upper corner.
- b. Drop FIT, BDX, GPX file(s) here or Click “Select files” to upload tracks.
- c. Click “Activities” to check uploaded tracks.

Share Your Tracks to Strava.com

1. Sign up / log in on Strava.com

- a. Go to <https://www.strava.com>
- b. Register for a new account or use your current Strava account to log in.

2. Connect to PC

Turn on your Rider 460 and connect it to your computer by USB cable.

3. Share Your Records

- a. Click “+” on the top right corner of the Strava page and then click “File”.
- b. Click “Select Files” and select FIT files from Bryton device.
- c. Enter information about your activities and then click “Save & View”.

Auto Sync Tracks to Bryton Active App

No more uploading tracks manually after riding. Bryton Active App automatically syncs your track after pairing with your Rider 460.

Sync via BLE

a. Scan QR code below to download Bryton Active App or go to Google Play/ App Store to search Bryton Active App. Then, log in or create an account.

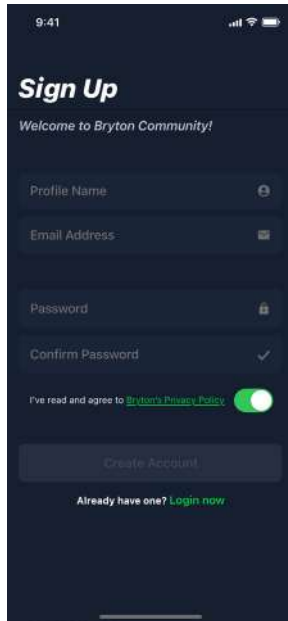

b-1. Go to Settings > My Device > Device Manager > + > Rider 460 to add your GPS device.

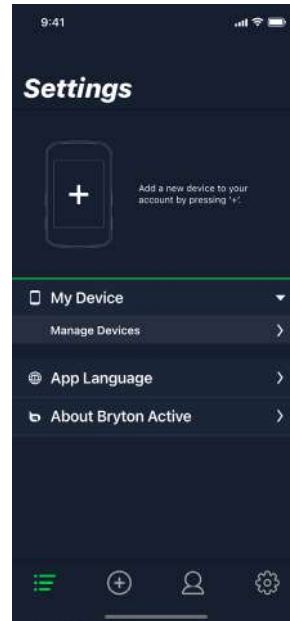

b-2. Check if the UUID shown on app is the same as your device. Select "OK" to confirm adding this device. If the UUID does not match, press Cancel and try again.

c. Successfully added! Turn on Activity Auto Sync. Now new tracks will be automatically uploaded to Bryton Active App.

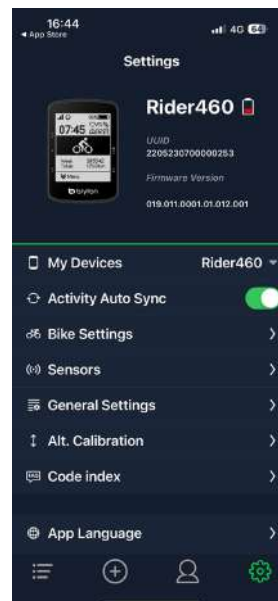
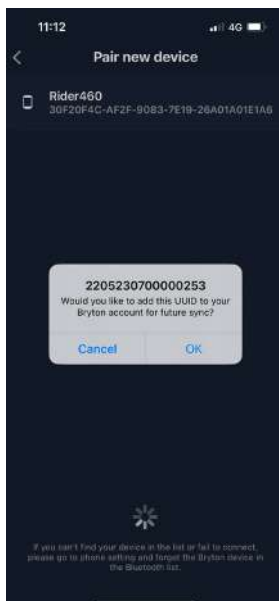

NOTE: Bryton Active App syncs with Brytonactive.com. If you already have a brytonactive.com account, please use the same account to log in to Bryton Active App and vice versa.

Firmware Update

Bryton Update Tool

Bryton Update Tool is the tool for you to update GPS data, and firmware and download Bryton Test.

1. Go to <http://www.brytonsport.com/#/supportResult?tag=BrytonTool> and download Bryton Update Tool.
2. Follow the on-screen instructions to install Bryton Update Tool.

Update GPS Data

The GPS data can speed up the GPS signal acquisition if it's not outdated. We highly recommend you update the GPS data every 1-2 weeks.

Update Firmware

Bryton releases a new firmware version on an irregular basis to add new functions or fix bugs. We highly recommend that you update the firmware once the latest version is available. It usually takes a while to download and install the firmware. Do not remove the USB cable during updating.

Update via Active app

You can choose to update the firmware via Bluetooth or with a proper cable.

For iOS phone

a. Connect the Rider 460 to your phone via Bluetooth.

b. The update message will pop up automatically, select Update to start the update. Or select Firmware Update to start updating.

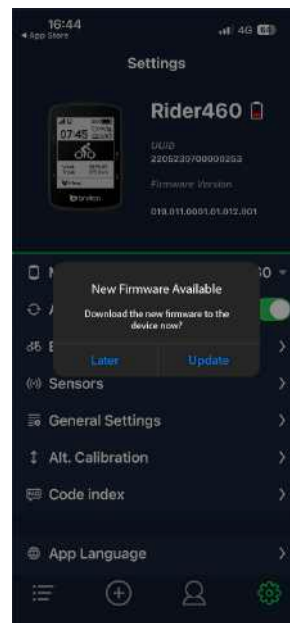
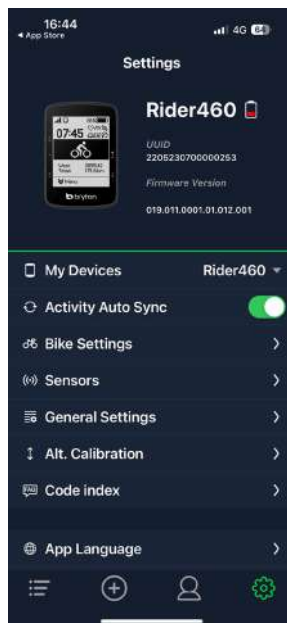
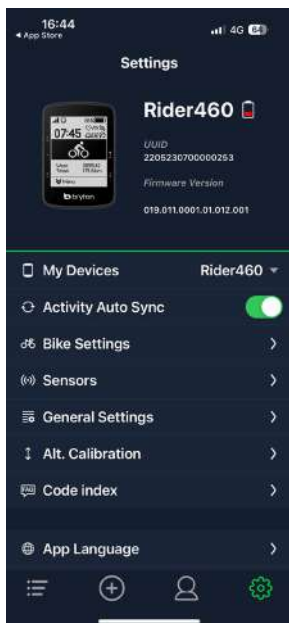

c. Choose to update the firmware with the Bryton cable or Bluetooth. You will need a USB-C to USB Adapter with Bryton original cable. Make sure the smartphone is connected to the device. Select the "BRYTON" root folder to allow Bryton Active app to get permission to access the device for downloading new firmware.

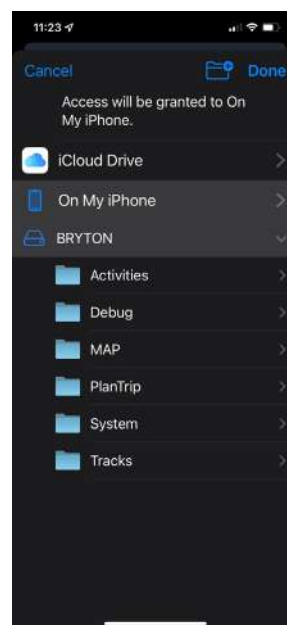
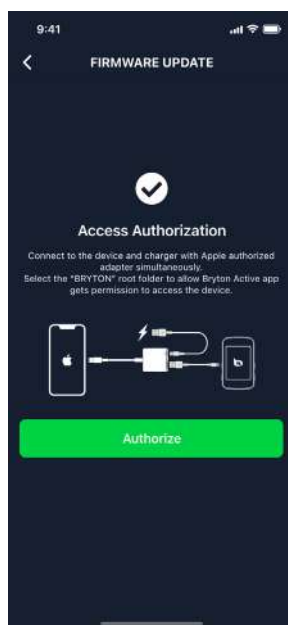
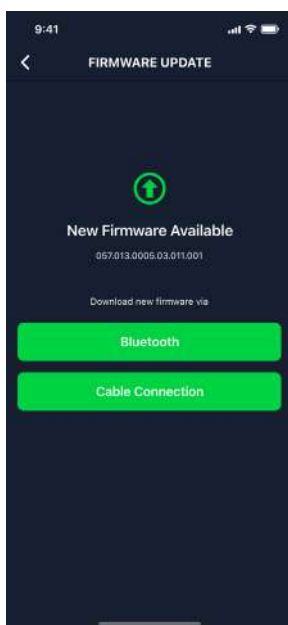

NOTE: You will need a lightning to USB adapter with Bryton original cable.

For Android phone

a. Connect the Rider 460 to your phone via Bluetooth.

b. The update message will pop up automatically, select Update to start the update. Or select Firmware Update to start updating.

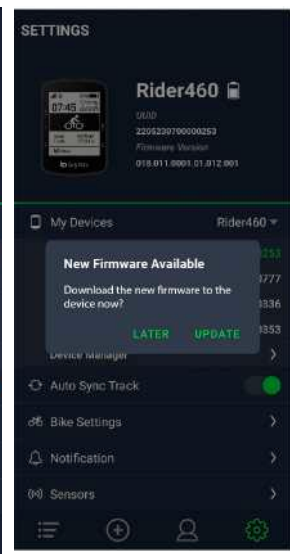
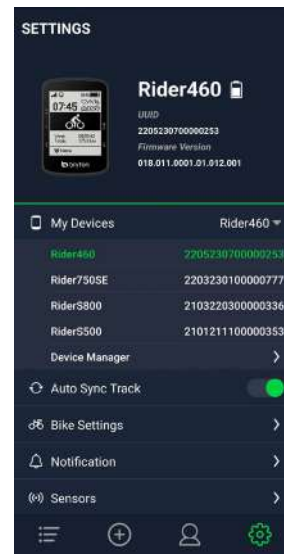
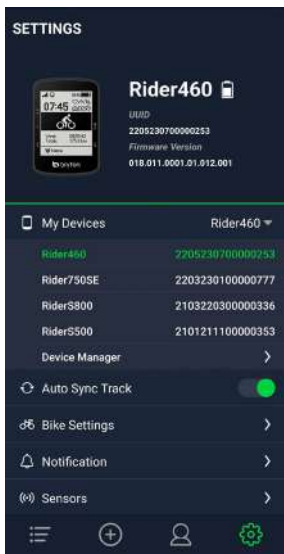

c. Choose to update the firmware with Bryton cable or with Bluetooth. If you are using the cable, please give the app permission to access phone storage.

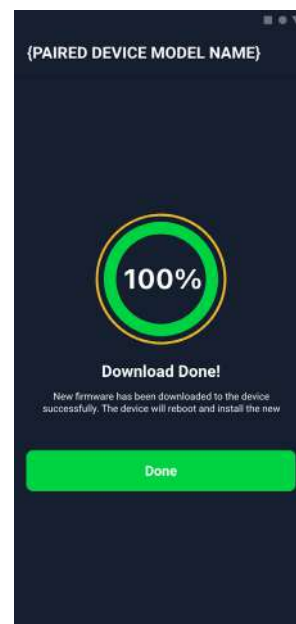
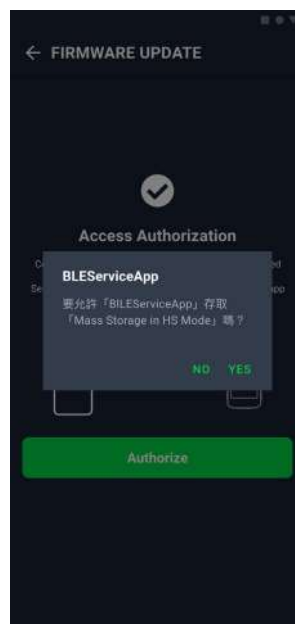
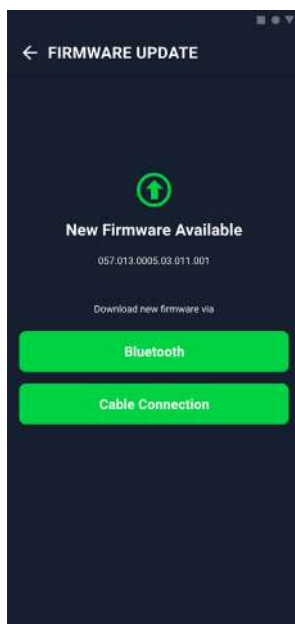

Course

Follow Track

Create Track

Rider 460 provides 3 ways to create tracks: 1. Plan trip via Bryton Active App. 2. Import routes from 3rd party platforms. 3. Auto sync routes from Strava, Komoot and RideWithGPS.

Plan Trips via Bryton Active App

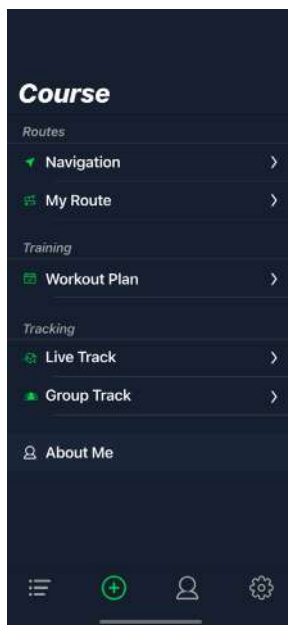

1. In Bryton Active App, select **Course > My Route > + > Plan trip** to set a Start point and Destination by tapping on the map or inputting address in the left Search Bar.
2. Upload the planned trip to **My Route** by tapping **Save**.
3. Go to **My Route** and select the route. Click the ... in the upper right corner to download the route to your Bryton device.
4. In the Device Main Menu, Click **Course > Route** to find the route and press **OK** to start following the track.

Import routes from 3rd-Party Platforms



1. Download routes in gpx file from 3rd party platform.
2. Select **Open in Active** (for iOS) or Open files with Bryton Active App (for Android).
3. Select **Course > My Route** in Bryton Active App.
4. Here you can see the routes imported to the App.
5. Select the upper right icon ... to download the route to your device.
6. In the Device Main Menu, Click **Course > Route** to find the route and press **OK** to start following the track.

Auto Sync routes from Strava, Komoot, RideWithGPS

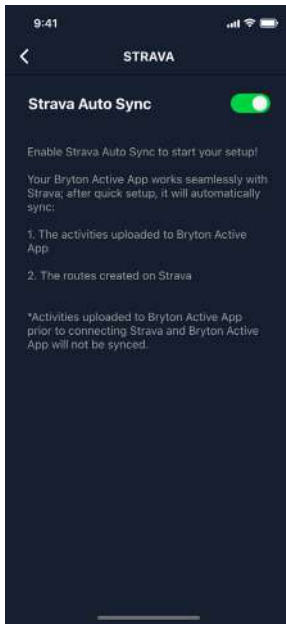

1. Enable STRAVA / Komoot / RideWithGPS auto sync in the **Profile > 3rd Party account link** tab.
2. Create/modify routes in these platforms and save them as public.
3. Go to **Course > My Route** to select the route you want to download. Click the “...” in the upper right corner to download the route to your Bryton device.
4. In the Device Main Menu, Click **Course > Route** to find the route and press **OK** to start following the track.

Add POI

After setting up your POI and Peak info, you can check the distance to your next POI or Peak in Route mode, allowing you to make the right decision based on your status and stay motivated along the way.

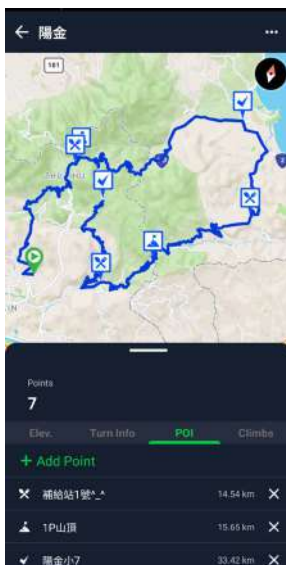

1. Go to **Course > My Routes** in Bryton Active App.
2. Select the route you would like to add POIs.
3. Press **POI** at the bottom, then click **+ Add POI**.
4. Choose a POI type by selecting the icon. Slide your finger on the bar below to place the POI anywhere along your route.
5. Press save and name the POI after confirming the position.
6. Click the ... in the upper right corner to download the route to your Bryton device.
7. In the Device Main Menu, Click **Course > Route** to find the route and press **OK** to start following the track.

Note:

1. Please pair the device with your smartphone before downloading the route to the device.
2. To view on-device POI info, please add the related POI data fields to the data pages. It is also recommended to put these data fields in larger grids to see complete information.

Route Guidance

After downloading routes to the Rider 460, you are able to follow the route.

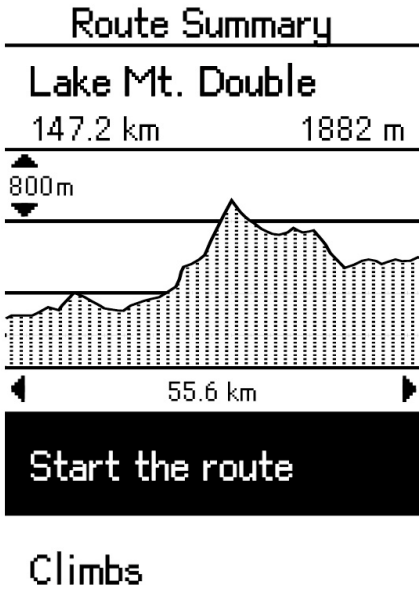

Select **Menu > Course > Route > select a desired route >** and press **OK** to start the route.

Climb Challenge

When you approach a climb, the Rider 460 will change to the Climb Section page, providing an overview of a route's climb segments. The Climb Challenge screen shows different patterns altitude map based on the gradient, distance remaining, and ascent remaining, giving you the climb information at-a-glance.

You can also check the climbs information in the saved route. Select **Menu > Course > Route > select a desired route > Climbs**.

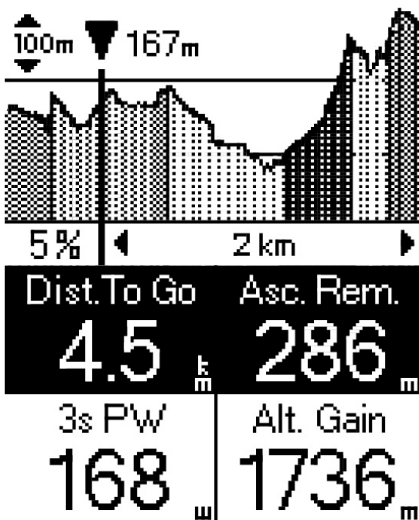

Total Climb Remain	
932 m	16.4 km
▼ 12.8 km	4.5%
Climb in Progress	
2 17.2 km	5.2%
↕ 556 m	↔ 10.5 km
3 38.6 km	6.1%
↕ 239 m	↔ 3.8 km

Workout

Create a Workout

Rider 460 provides 2 ways to create workout: 1. Plan workout via Bryton Active App.
2. Sync workout from TrainingPeaks.

Plan workout via Bryton Active App



1. In Bryton Active App, select **Course** > **Workout Plan** > **My Workout** > **“+”** > **Plan Workout** to plan a training workout by selecting interval types and enter details.
2. Select a workout and click **“...”** in the top right to download the workout to the device.

Sync workout from TrainingPeaks



1. Create a workout plan on TrainingPeaks website.
2. Enable TrainingPeaks auto sync in the Course tab or in **My Workout** > **“+”** > **3rd party account link** to establish a link with the Bryton Active app.

Train with a Workout plan

1. Select **Menu > Course > Workout**.
2. You can see the workout plans, which are downloaded from the app.

Start Workout

1. Press **≡** to select the workout you would like to start with.
2. Press the **OK** to start the workout

End Workout

1. Long press **≡** to enter the quick menu. Choose **“End workout”** to end the workout immediately.
2. You can go to **Monthly total** to see your cycling data.

Delete Workout

1. To delete the workout, select **delete**
2. Press **≡** to select the workout you want to delete
3. Press **^** to Select delete
4. Press **OK** to delete selected workout

Workout	
Delete	
40/20's into FTP	31 Steps
00:55:00	
Devedeset Lite	14 Steps
00:32:00	
Foundation	19 Steps
00:48:00	

3/12	
92	128
216	
00:01:18	
3s PW	HR
238	138
KJ	Ttl. Remain
536	00:29:44

Group Ride

Join Group Ride

The Group Ride needs to work with the Bryton Active app. Please make sure you pair the Rider 460 with the Bryton Active app on your smartphone



Create Group Ride

1. Select **Course** on Bryton Active app.
2. Select **Group Ride**
3. Tap on **Create New Group**
4. Enter all the details for the group ride.
5. You will need to have an existing route in the Bryton Active app. Go to Page [14](#) to see how to create a route.
6. Complete creating group ride
7. Turn on the Rider 460 and enter **Menu Select Course and select Group Ride.**
8. Select **Start Group Ride** to start riding.

Enter Group Code

1. Paste the code in the blank then press **Join or use the link to enter the group**
2. Turn on the Rider 460 and enter **Menu select Course and select Group Ride.**
3. Select **Start Group Ride** to start riding.

Group Chat

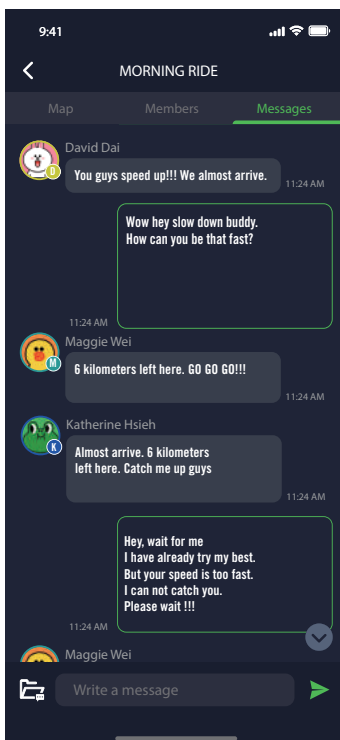

On 460

When the message comes, it will pop up on the bottom of 460.

(If you want to see more messages, please use APP to check messages)

On App

You can use Bryton Active app to send messages to the members in the group.

1. Tap on Chats, then type a message or click to send a quick response.
2. You can edit/add the message at the bottom.

LIVE TRACK

Share your real-time location with friends and family using the Live Track feature. Before using, please ensure that Rider 460 is already recording a ride by pressing the record button and then opening the Bryton Active app on our smartphone. This feature will not work if the device is not recording.

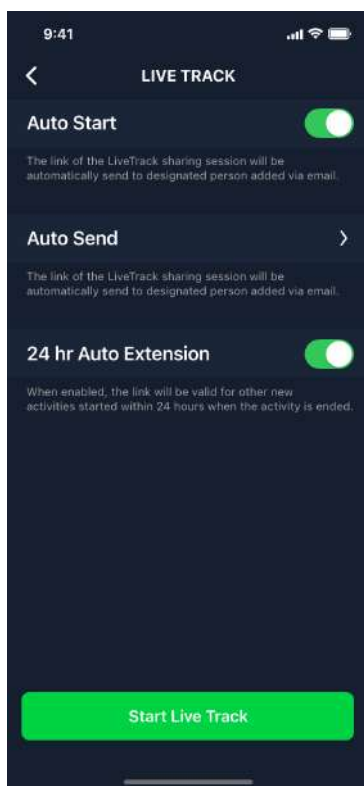

Activate LIVE TRACK

Select **Course** on the Bryton Active app.

Select **LIVE TRACK**.

Toggle the Share Location status or press the **Start Live Track** button.

Note: Once LIVE TRACK is successfully activated, you can find the LIVE TRACK icon appears on the top of Rider 460.

Auto Send LIVE TRACK Link

Select Auto Send and toggle the activation status.

Fill out the email address on the column of the Share the activity with and you can type in a custom message.

Hit  sign to confirm adding the email.

Manually Share LIVE TRACK Link

Press  the icon in the bottom left-hand corner.

Select the contact you would like to share with.

24-Hour Auto Extension

When you enable this option, the LIVE TRACK link will remain valid for another 24 hours after the ride has ended. With this link, anyone you share with can still view your last or ongoing activity.

If you start a new ride within this 24-hour window, the link will display the new ride instead of the old one. This is useful when embarking on a multi-day bike trip or when sharing your daily commute, making it more convenient for family or friends to use the same link to track your progress.

End LIVE TRACK

When you end your ride, the Rider 460 will display a “LIVE TRACK Ended” notification to let you know your ride is no longer being tracked. You can also end the live track from the Bryton active app by pressing the End Live Track button in the bottom.

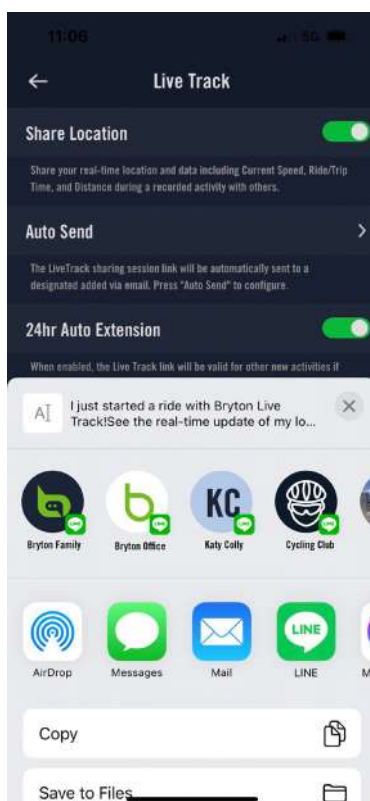

Smart Training

Set up a Trainer

1. Select **Menu > Course > Smart Training**
3. Select a smart trainer you want to connect to Rider 460.

Edit Information

Go to **Trainer Settings** to enter Wheel Size, Gear Ratio, and Bike Weight to set up a smart trainer profile.

Remove Trainers

1. Go to **Trainer Settings**.
2. Select **Remove** to select the smart trainer you want to remove.
3. If you stop peddling for a while, the smart trainer will automatically disconnect.

Trainer Setting	
ID	17960
Type	ANT+
Wheel Size	2096 mm
Bike Weight	8.2 kg
Remove	

Resistance / Slope / Power

1. Select **Menu > Course > Smart Training > Set Resistance(Slope/Power)**.

Start Resistance(Slope/Power) Workout

1. To adjust the intensity, long press **^** to activate/quit page control mode. In this mode, use **^ / ≡ v** to adjust the intensity instead of changing meter pages.
2. You can switch to different control mode in the quick menu.
3. Resistance (Slope/Power) training will automatically stop when the Smart Trainer lost connection.

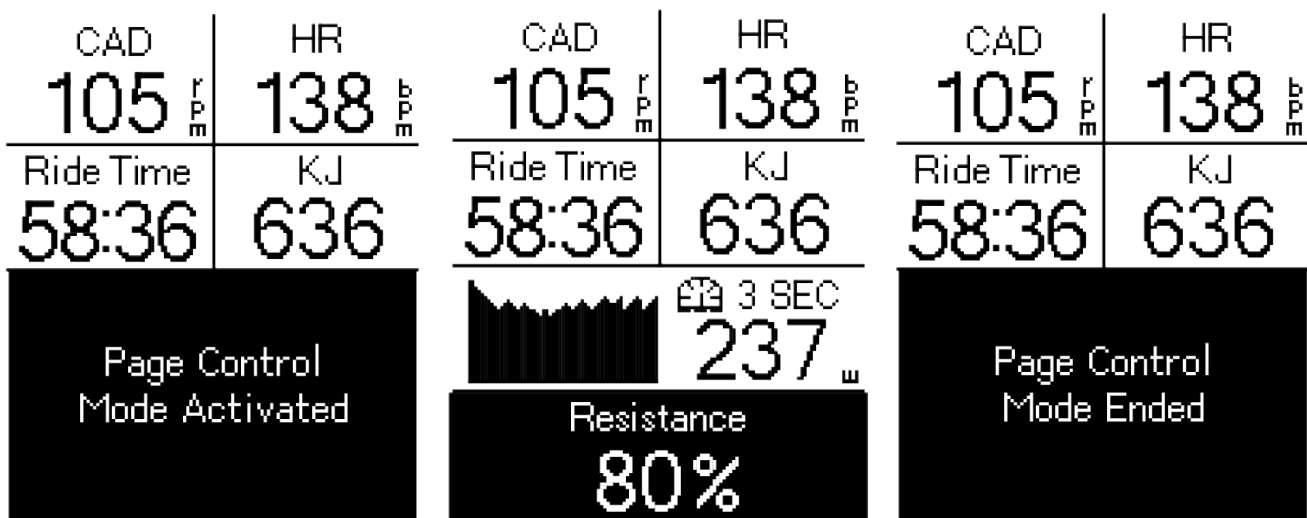

Note: You need to connect a smart trainer to the Rider 460 before having access to the Smart Workout, Resistance, and Power Workout.

Smart Workout

Training plans can be built with the Bryton Active App and downloaded directly to the Rider 460. With ANT+ FE-C support, the Rider 460 will communicate with your smart trainer to control the resistance according to the training plan.

1. Select **Menu > Course > Smart Training > Workout**.
2. You can see the workout plans, which are synced from the app.



Start Workout

1. Select the workout you would like to start with.
2. Press the **OK**  to start the workout.

End Workout

1. Long press  to enter the quick menu. Choose **"End workout"** to end the workout immediately.
2. You can go to **Monthly Total** to see your cycling data.

Delete Workout

1. To delete the workout, select **delete**
2. Press  to select the workout you want to delete
3. Press  to Select delete
4. Press **OK**  to delete selected workout



Navigation on Bryton Active App

1. Pair the Rider 460 with Bryton Active App, select **Course > Navigation**.
2. Input keywords or address or POI in the search bar then click Q.
3. Select a result from the search list.
4. Confirm the location then click **Plan Route** to see the route.
5. Click **Download to Device** to start navigation on Rider 460.

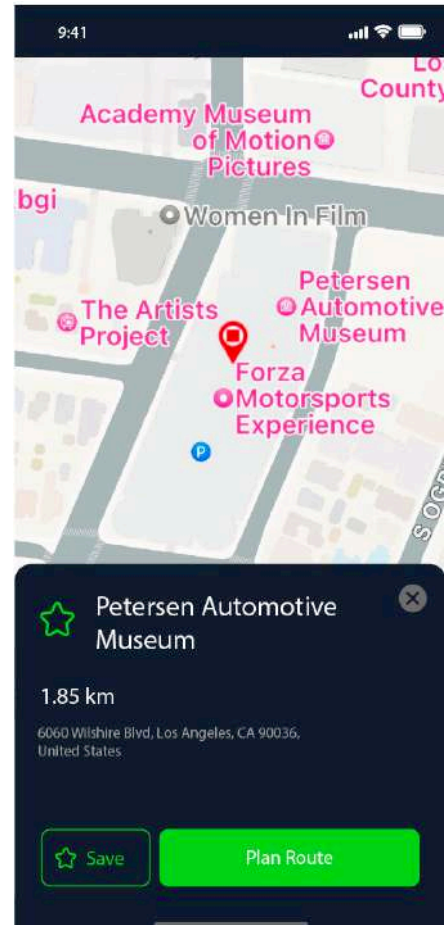

Result

You can view recorded activities on the Rider 460 or delete records to save more storage capacity of the device.

View Records

1. Select "Monthly Total" on the home page.
2. Pick a record to view details.

Results	
2023/12/31	06:56
Ride	Trip
03:53:47	05:13:51
Distance	
61.1	km
Altitude Gain	
1630	m
Speed	
km/h	
Avg	Max
15.7	50.6
Cadence	
rpm	
Avg	Max
89	117
Heart Rate	
bpm	
Avg	Max
140	163

Delete Record

1. Select "Monthly Total" on the home page.
2. Press **OK** to delete result.
3. Choose the record(s) then tap to delete the record.
4. Press to confirm.

Results	
Delete	
2023/12/14	
05:01:34	90.8 km
2023/12/11	
03:53:47	61.1 km
2023/12/06	
05:17:56	100.4 km

Settings

In Settings, you can customize Display, Sensors, System, Altitude, and more. You can also find firmware information in this section. In addition, you can customize most of the device settings via the Bryton Active app.

Data Page

1. Select “” on the home page to turn on data pages .
2. Press \wedge to preview data pages. Press \wedge / \equiv \vee to scroll data pages. Press \rightarrow to return to the home page

Speed	
32.8 <small>km/h</small>	
Ride Time	Distance
58:36	28.6 <small>km</small>
Avg Speed	Alt. Gain
29.3 <small>km/h</small>	1736 <small>m</small>

Note: Connect the Rider 460 to your phone via Bluetooth. You can use Bryton Active APP to modify Grids numbers and Data Pages.

Display

You can change the display settings such as Brightness, Backlight, and Contrast.

1. Long press down to enter the menu.
2. Select Menu > Settings
3. Select Display > Backlight

Brightness

You can choose to set the brightness as 0%, 25%, 50%, 75%, 100%

Display	Backlight
Backlight	Brightness 100%
Contrast 50%	Duration Stays On

Backlight Duration

1. Press up and down to select a preferred duration.
2. Smart option adjusts backlight based on sunrise/sunset.
3. Stays On option allows the backlight to keep turning on.

Pair Sensors

Pair your sensors with the device beforehand. Rider 460 will scan nearby active paired sensors, making switching between bikes and sensors easier and more convenient.

1. Long press  to enter the menu.
2. Select **Menu > Settings > Sensors**

Add New Sensors

1. Select **Add New** to add new sensors.
2. Choose any type of sensor that you would like to pair with.
3. To pair sensors with your device, please have Bryton Smart Sensors installed first, then wear a heart rate monitor or rotate the crank and wheel a few times to wake Bryton Smart Sensors up.
4. For Bike Radars, E-bikes, and Ess/Di2, please turn the power on before starting pairing.
5. Let the device detect sensors automatically or select to enter a sensor ID manually.
6. Pick a detected sensor you would like to pair with then select to save.

Deactivated sensors

1. Select the sensor you would like to deactivate.
2. Press **OK**  to turn off the status then sensors will be deactivated.

Activate Paired Sensors

1. Select the sensor you would like to activate.
2. Press **OK**  to turn on sensor status then sensors will be connected automatically.
3. If the sensor fails to be connected or you want to switch to this sensor, select to reconnect it with your device.

Remove sensors

1. Choose the sensor you would like to remove.
2. Select **Remove** to remove the sensor.

Switch Sensors

1. If another paired sensor is detected, the device will ask you if you want to switch to another sensor.
2. Press **OK**  to switch the sensor.

NOTE:

- If you select X in the sensor found notification, the detected sensor will not be detected and connected until the device reboot. You can toggle its status off/on to activate it again.
- Sensors only need to be switched if they are in the same type and both are already added in the list.

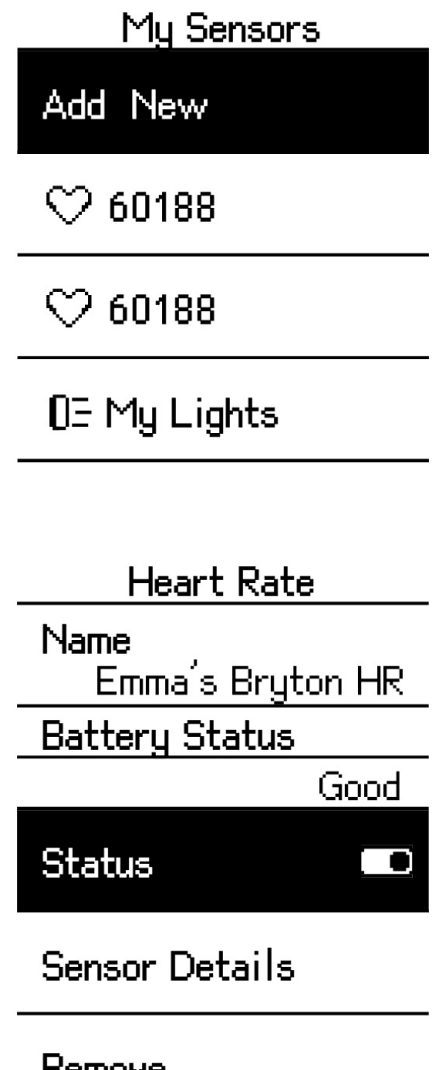

Using Electronic Shifting Systems

After pairing electronic shifters, such as Shimano Di2 or SRAM, you can enter the sensor pages for further settings. To customize the data grids on meter pages, please go to page 24 for more instruction.

Di2	Rear Gear
Name/ID 30909	Gear Presets
Type ANT+	Gear 2
	Gear 1 36
	Gear 2 52
	Gear 3

Connect

1. Select Menu > Settings > Sensor > Add Sensor.
2. Select the Di2 and pair.
3. Enter Sensor Details to input the tooth numbers.

Remote Control	Remote Control
None	Left Single Press Start/Stop/OK
Start/Stop/OK	Right Single Press Lap/Back
Lap/Back	Left Long Press Previous Page
Previous Page	Right Long Press Next Page
Next Page	

Remote Control

1. Enter Remote Setup
2. Press  v to set up different functions for each button.

Manage Sensors via Bryton Active App

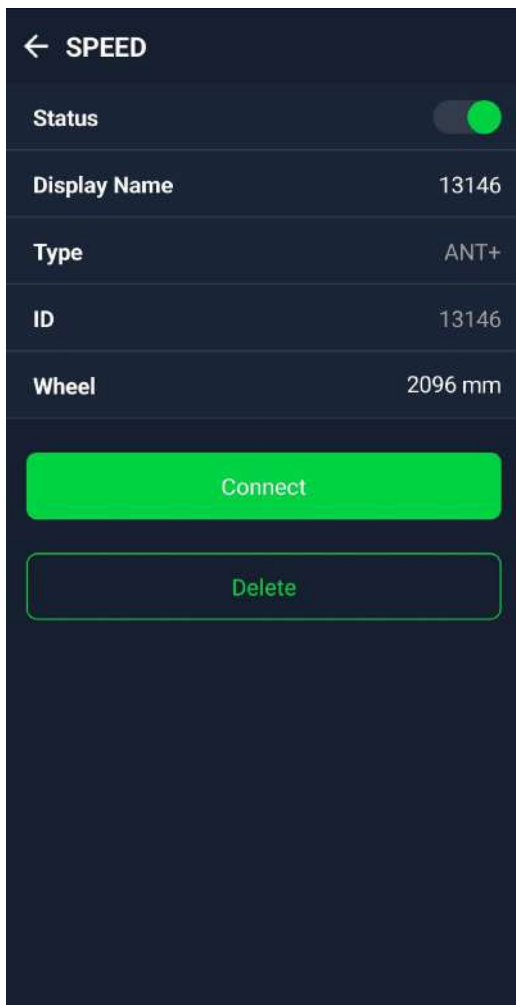

1. Select Settings on the home page.
2. Find Sensors.

Add New Sensors

1. Select **Add Sensor** to add new sensors.
2. Choose any type of sensor that you would like to pair with.
3. To pair sensors with your device, please have Bryton Smart Sensors installed first, then wear a heart rate monitor or rotate the crank and wheel a few times to wake Bryton Smart Sensors up.
4. For Bike Radars, E-bikes, and Ess/Di2, please turn the power on before starting pairing.
5. Let the device detect sensors automatically or enter a sensor ID manually.
6. Pick a detected sensor you would like to pair with then select OK to save.

Manage Sensors

1. Select the sensor you would like to edit.
2. Turn on or off the status to activate or deactivate the sensor.
3. Edit the name by clicking the display name.
4. Remove the sensor by pressing Delete.

Switch Sensors

1. Select the sensor you would like to switch to.
2. Press Connect to pair the sensor.

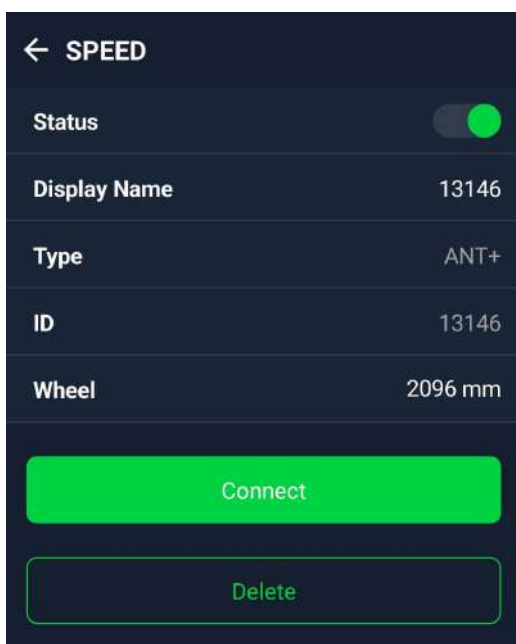

NOTE: Sensors only need to be switched if they are in the same type and both are already added in the list.

Bike Radar

Speed	Ride Time
29.3 <small>km/h</small>	58:36
Distance	
54.5	
Time	HR
06:38	138
Alt. Gain	Grade
673 <small>m</small>	3

1. Go for a ride.
2. The Gardia radar's status and information will be displayed on the data screen.
3. The vehicle's position will move up the screen as the vehicle approaches your bike.

Note:

1. If there is no vehicle around you, the strip will not show on the screen.
2. Please go to Page 38 to see how to pair a bike radar with Rider 460.

Using E-bike

The Rider 460 incorporates Shimano Steps and ANT+ LEV e-bike support for compatible brands to display various e-bike data, including assist mode, assist level shifting mode, E-Bike battery, travel range and rear gear position.

Ride Time	
58:36	
Assist Mode	
32 %	
Battery	Speed
75 %	29.3 <small>km/h</small>
3s Power	Grade
76 <small>w</small>	3 %

1. Before you can use a compatible E-bike, you must pair it with the Rider 460.
2. You can customize the compatible E-bike data fields.

System

In System, you can customize Time / Unit, Language and Data Reset.

1. Long press down to enter the menu.
2. Select Menu > Settings > System

Language

1. Select your desired language.
(or you can set it up on Bryton Active APP)

Time / Unit

1. Select Daylight Saving, Date Format, Time Format, Unit, and Temperature to change the settings.

System

Time/Unit

Language

Data Reset

Time/Unit

Daylight Saving
+0:00

Date Format
dd/mm/yyyy

Time Format
12 hr

Unit
KM,KG

Temperature

Altitude

With connection to the Internet, Bryton Active APP provides altitude information for you to calibrate directly. You can also change altitude manually.

Calibrate Altitude

1. Long press down to enter the menu.
2. Select Menu > Settings > Altitude
3. Select **Calibrate**
4. Press Up and Down to adjust to change the value.

The diagram illustrates the manual calibration process. On the left, a screen shows the 'Altitude' menu with a value of 618. An upward arrow indicates the current value, and a downward arrow indicates the target value. Below the screen, text instructs the user to 'Long press to fast scroll the options.' On the right, a screen shows the 'Altitude' menu with a value of 231 m. A downward arrow indicates the current value, and a message prompts the user to 'Please make sure you're at ground level for more accurate calibration.' Below the screen is a black button labeled 'Calibrate'.

NOTE:

The value of altitude on the meter mode will be changed once current altitude is adjusted.

About

You can view your device's current firmware version.

1. Long press down to enter the menu.
2. Select Menu > Settings > About
3. Firmware information and current latitude and longitude will show on the device.

The screenshot shows the 'About' screen with the following information:

- Rider 460
- GPS Enabled
- Cycling Computer
- UUID 2101211000000163
- Ver. 055.009.0006 04.011.001
- MFG 2023.07
- LAT/LONG 25.08029364111098, 121.5711967966796
- Satellite Found 0
- ©2023 Bryton Inc. All Right Reserved.

Bryton App Settings

After pairing your Rider 460 with Bryton Active App, you can set up more Settings and receive notifications.

General Setting

Keytone

1. Enable or disable Key Tone to change the settings for key presses.

Sound

1. Turn on or off Sound to change the settings for alerts and notifications.

ODO

the cumulative distance of all trips while you are using Rider 460.

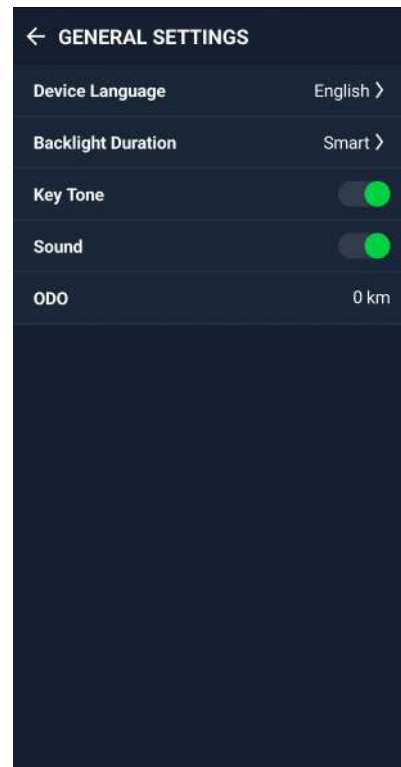

Notifications

After pairing your compatible smartphone via Bluetooth with Rider 460, you can receive phone calls, texts and email notifications on your Rider 460.

1. iOS Phone Pairing

- a. Go to your phone “Settings>Bluetooth” and enable Bluetooth.
- b. Go to Bryton Active App and Tap on “Settings>Device Manager>+”.
- c. Select and add your device by pressing “+”.
- d. Tap on “Pair” to pair your device with your phone. (For iOS phone only)
- e. Tap on “Finish” to complete pairing.

NOTE: If notifications do not work properly, in your phone, please go to “Settings>Notifications” and check if you have allowed notifications in compatible messaging and email apps or go to social applications settings.

1. Android Phone Pairing

- a. Go to your phone “Settings>Bluetooth” and enable Bluetooth.
- b. Go to Bryton Mobile App and Tap on “Settings > My Devices > Device Manager >+”.
- c. Select and add your device by pressing “+”.
- d. Tap on “Finish” to complete pairing.

2. Allow Notification Access

- a. Tap on “Settings> Notification”.
- b. Tap on “OK” to enter setting to allow Notification Access for Bryton app.
- c. Tap on “Active” and select “OK” to allow notification access for Bryton.
- d. Go back to Notification settings.
- e. Select and enable In-coming Calls, Text Messages and Emails by Tap onping each item.

Profile

You only can edit the Profile via Bryton Active App. Just edit your profile info in the profile tab in Bryton Active. Once the device is connected to the app, your profile info will be updated to your Rider 460.

About Me

In Profile,select **About Me**, you can browse and personalize your information.

Heart Rate Zone&Power Zone

1. Select **PROFILE > Heart Rate Zone&Power Zone** and tap to edit details..

Customize Heart Rate Zone

- 1.Select **MHR/ LTHR**.
- 2.Press to edit details for each zone.
- 3.Scroll up and down to edit more zones.

Customize Power Zone

- 1.Select **FTP**.
- 2.Press to edit details for each zone.
- 3.Scroll up and down to edit more zones.

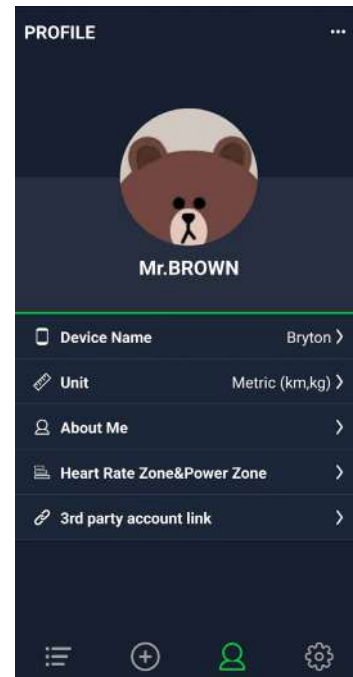

Bike Settings

Page

Select **Settings > Bike Settings > Data Page** you can customize grid number and data grids

Overview

1.Select **Settings > Bike Settings > Overview** to view more details of the bike odometer.

Auto Feature

Select **Settings > Bike Settings > Auto Feature**
You can toggle on or off **Auto Lap / Smart Pause**

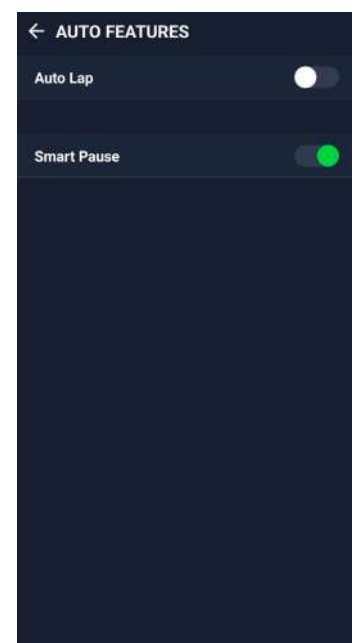
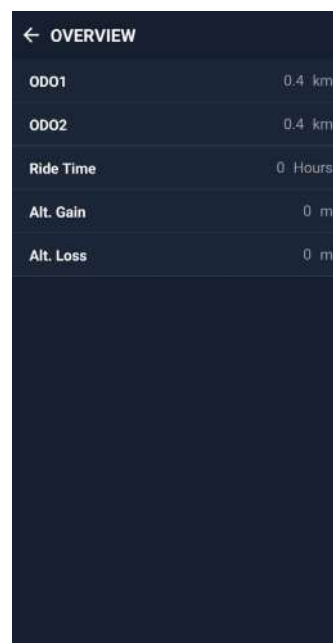
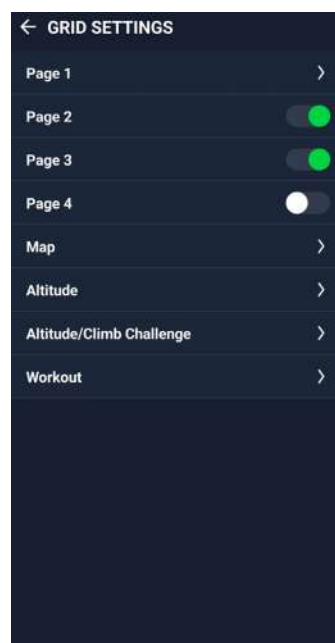
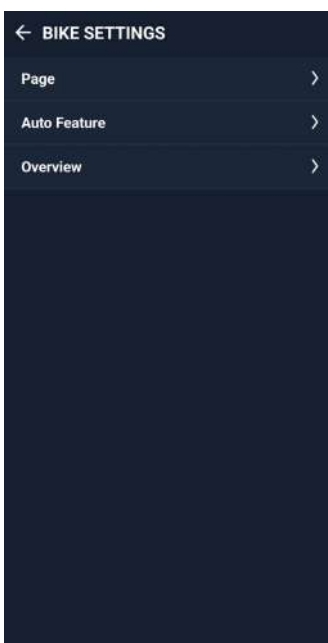

Appendix

Specification

Rider 460

Item	Description
Display	2.6" Mono LCD
Physical Size	53.8x79.8x12.6
Weight	58g
Operating Temperature	-10°C ~ 50°C
Battery Charging Temperature	0°C ~ 40°C
Battery	Li-polymer rechargeable battery
Battery Life	Up to 32 hours with open sky
ANT+™	Featuring certified wireless ANT+™ connectivity. Visit www.thisisant.com/directory for compatible products. 
GNSS	Integrated high-sensitivity GNSS receiver with embedded antenna
BLE Smart	Bluetooth smart wireless technology with embedded antenna; 2.4GHz band 0dBm
Water Resistant	Water resistant to a depth of 1 meter for up to 30 minutes
Barometer	Equipped with barometer

NOTE: Accuracy may be degraded by poor sensor contact, electrical, magnetic interference and distance from the transmitter. To avoid magnetic interference, it is recommended that you change location, clean or replace chain.

Smart Cadence Sensor (Optional)

Item	Description
Physical Size	36.9 x 31.6 x 8.1 mm
Weight	6 g
Water Resistance	Incidental exposure to water of up to 1 meter for up to 30 minutes
Transmission Range	3 m
Battery Life	Up to 1 year
Operating Temperature	-10°C ~ 60°C
Radio Frequency/protocol	2.4GHz / Bluetooth 4.0 and Dynastream ANT+ Sport wireless communications protocol

NOTE:

Accuracy may be degraded by poor sensor contact, electrical, magnetic interference and distance from the transmitter.

Smart Heart Rate Monitor (Optional)

Item	Description
Physical Size	63 x 34.3 x 15 mm
Weight	14,5 g (sensor) / 31,5 g (correa)
Water Resistance	Incidental exposure to water of up to 1 meter for up to 30 minutes
Transmission Range	3 m
Battery Life	Up to 2 years
Operating Temperature	0°C ~ 50°C
Radio Frequency/protocol	2.4GHz / Bluetooth 4.0 and Dynastream ANT+ Sport wireless communications protocol

Battery Information

Smart Cadence Sensor

Smart Cadence sensors contain a user-replaceable CR2032 battery.

Before using sensors:

1. Locate the circular battery cover on the back of sensors.
2. Use your finger to press and twist cover counter-clockwise so the indicator on the cover points to unlock icon (🔓).
3. Remove the cover and battery tab.
4. Use your finger to press and twist cover clockwise so the indicator on the cover points to locked icon (🔒).

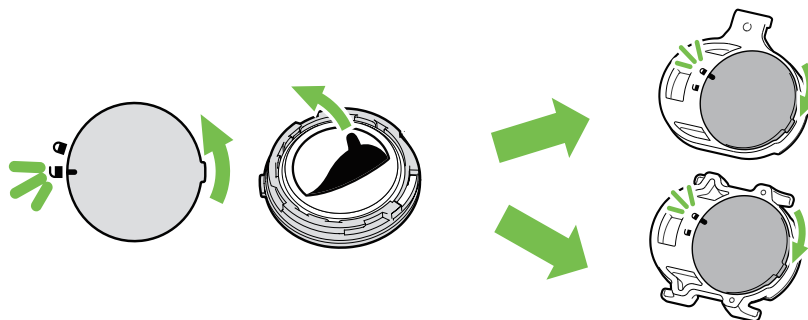

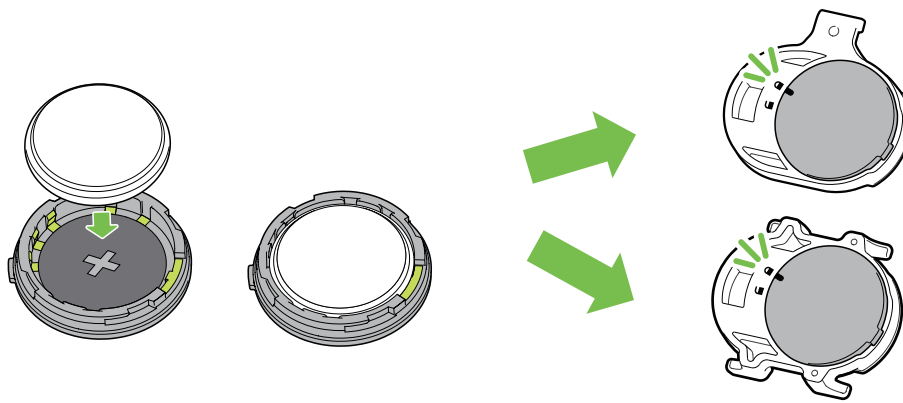

To replace the battery:

1. Locate the circular battery cover on the back of sensors.
2. Use your finger to press and twist cover counter-clockwise so the indicator on the cover points to unlock icon (🔓).
3. Remove the battery and insert new battery with positive connector first into the battery chamber.
4. Use your finger to press and twist cover clockwise so the indicator on the cover points to locked icon (🔒).

NOTE:

- When installing a new battery, if the battery is not placed with the positive connector first, the positive connector will easily deform and malfunction.
- Be careful not to damage or lose O-ring gasket on the cover.
- Contact your local waste disposal department to properly dispose of used batteries.

Smart Heart Rate Monitor

The heart rate monitor contains a user-replaceable CR2032 battery.

To replace the battery:

1. Locate the circular battery cover on the back of the heart rate monitor.
2. Use a coin to twist the cover counter-clockwise.
3. Remove the cover and battery.
4. Insert the new battery, with the positive connector facing upward and lightly press it.
5. Use a coin to twist the cover clockwise.

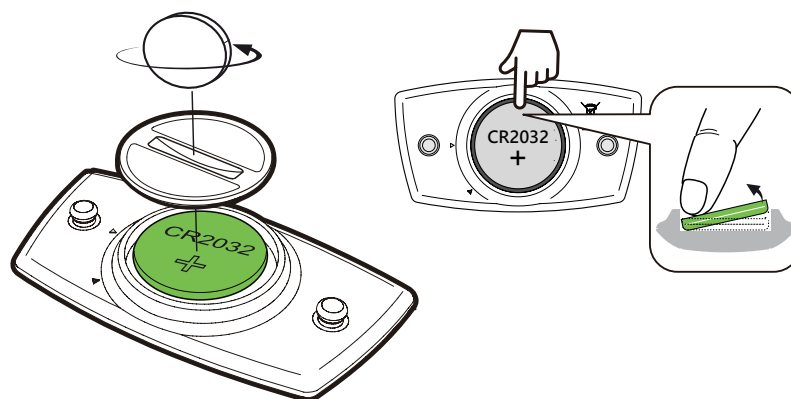

NOTE:

- Be careful not to damage or lose the O-ring gasket.
- Contact your local waste disposal department to properly dispose of used batteries.

Install Rider 460

Use Sport Mount to Mount Rider 460

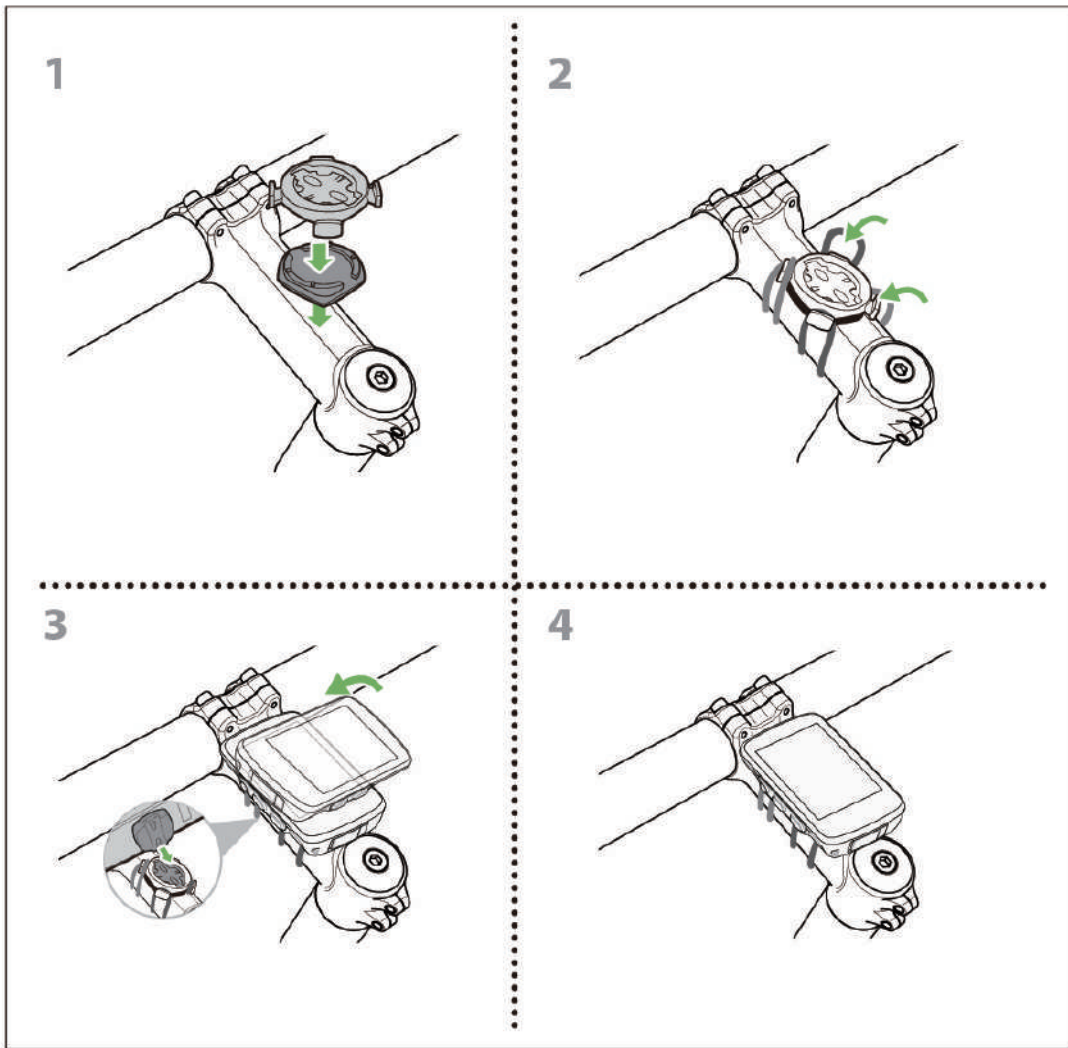

Use F-Mount to Mount Rider 460

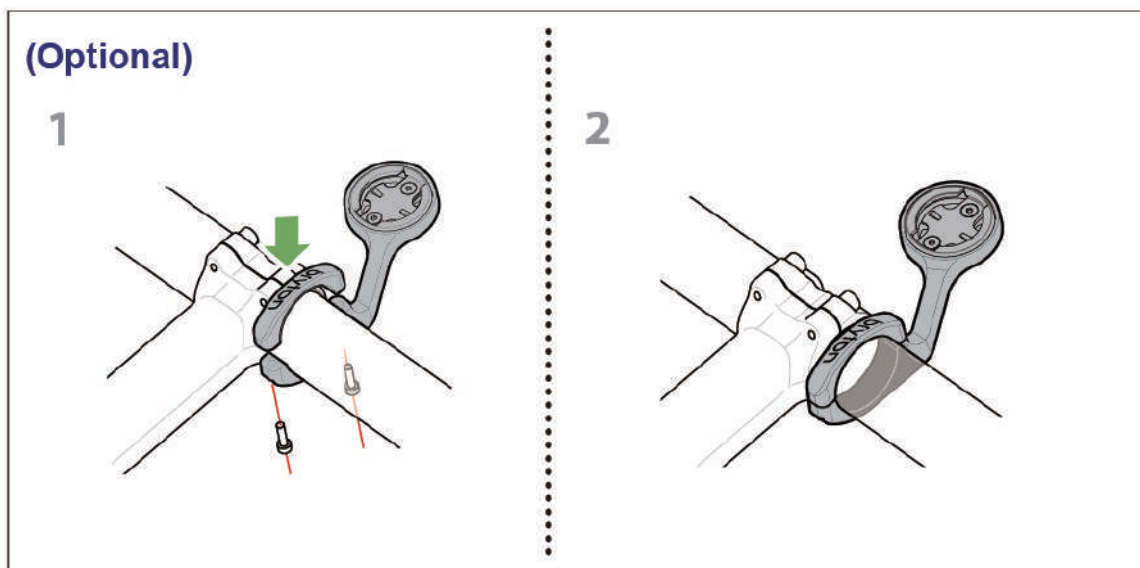

Install the Cadence Sensor (Optional)

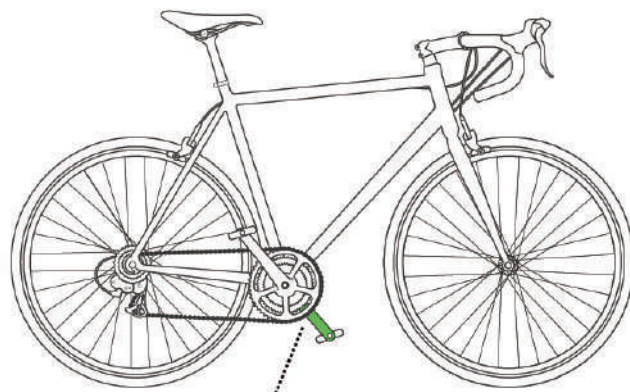

Cadence Sensor

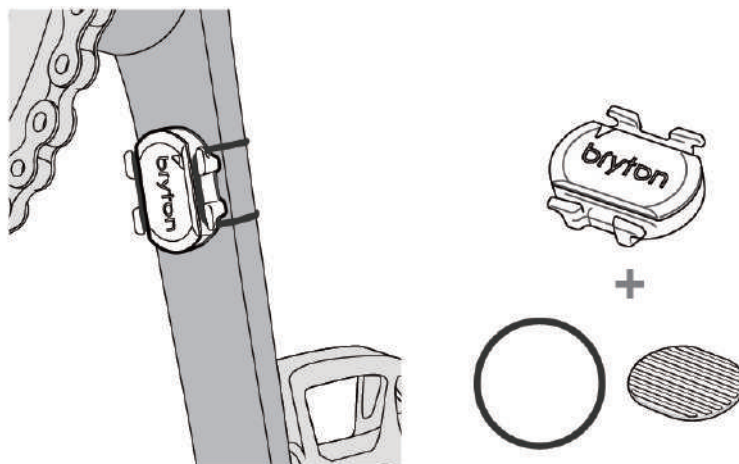

NOTE:

- Once sensors are waken, the LED blinks twice. The LED continues to blink when you continue to pedal for pairing. After around 15 times blink, it stops blinking. If not used for 10 minutes, sensor would go into sleep mode to preserve power. Please complete the pairing during the time the sensor is awake.

Install Heart Rate Belt (Optional)

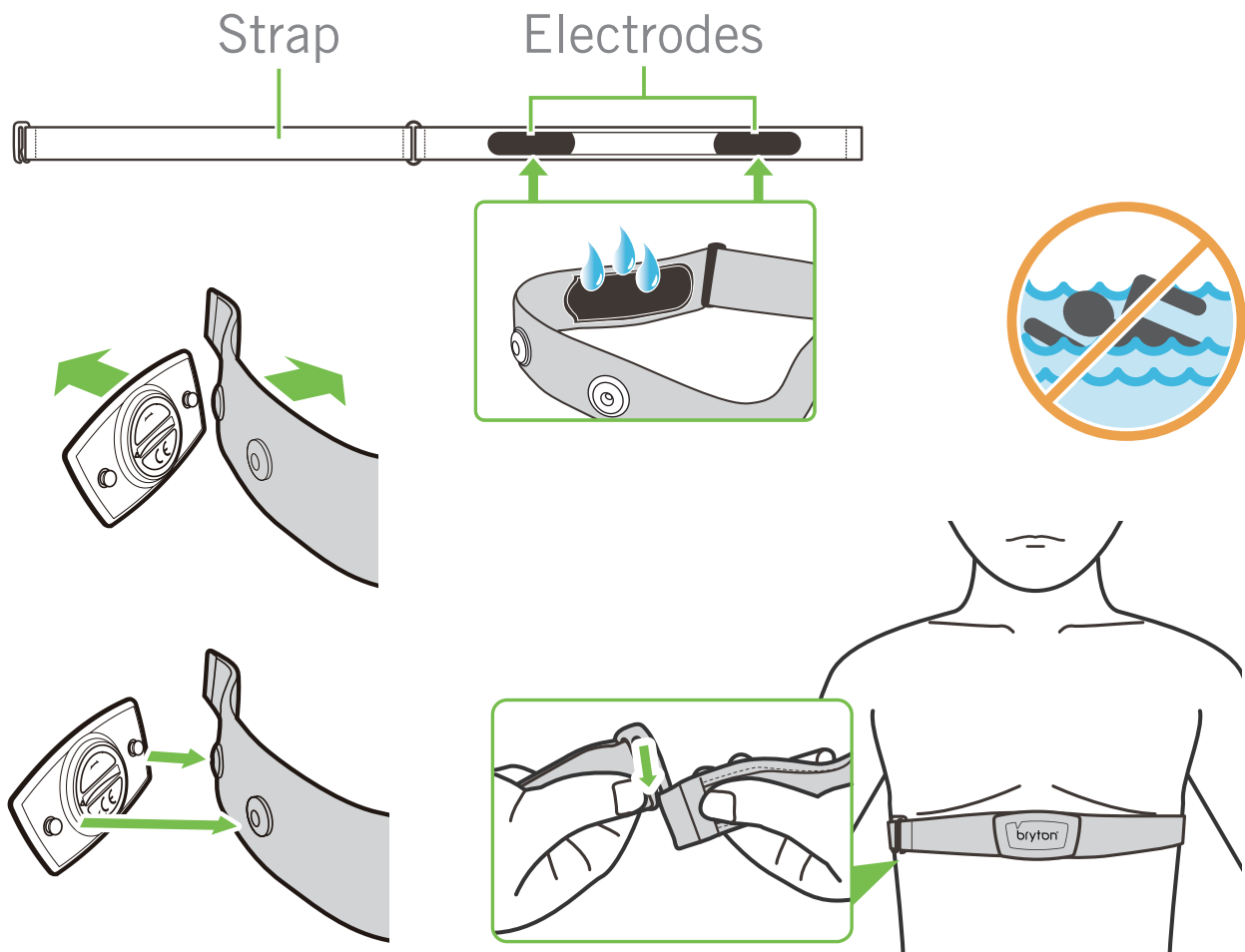

NOTE:

- In cold weather, wear appropriate clothing to keep the heart rate belt warm.
- The belt should be worn directly on your body.
- Adjust the sensor position to the middle part of the body (wear it slightly below the chest). The Bryton logo shown on the sensor should be facing upward. Tighten the elastic belt firmly so that it will turn loose during the exercise.
- If the sensor cannot be detected or the reading is abnormal, please warm up for about 5 minutes.
- If the heart rate belt is not used for a period of time, remove the sensor from the heart rate belt.

NOTE: Improper battery replacement may cause an explosion. When replacing a new battery, use only the original battery or a similar type of battery specified by the manufacturer. Disposal of the used batteries must be carried out in accordance to the regulations of your local authority.



For better environmental protection, waste batteries should be collected separately for recycling or special disposal.

Wheel Size and Circumference

The wheel size is marked on both sides of the tires.

Wheel Size	L (mm)
12x1,75	935
12x1,95	940
14x1,50	1020
14x1,75	1055
16x1,50	1185
16x1,75	1195
16x2,00	1245
16 x 1-1/8	1290
16 x 1-3/8	1300
17x1-1/4	1340
18x1,50	1340
18x1,75	1350
20x1,25	1450
20x1,35	1460
20x1,50	1490
20x1,75	1515
20x1,95	1565
20x1-1/8	1545
20x1-3/8	1615
22x1-3/8	1770
22x1-1/2	1785
24x1,75	1890
24x2,00	1925
24x2,125	1965
24 x 1 (520)	1753
Tubular 24 x 3/4	1785
24x1-1/8	1795
24x1-1/4	1905
26 x 1 (559)	1913
26x1,25	1950
26x1,40	2005
26x1,50	2010
26x1,75	2023
26x1,95	2050
26x2,10	2068
26x2,125	2070
26x2,35	2083

Wheel Size	L (mm)
26x3,00	2170
26x1-1/8	1970
26x1-3/8	2068
26x1-1/2	2100
650C Tubular 26 x 7/8	1920
650x20C	1938
650x23C	1944
650 x 25C 26 x 1 (571)	1952
650x38A	2125
650x38B	2105
27 x 1 (630)	2145
27x1-1/8	2155
27x1-1/4	2161
27x1-3/8	2169
27,5x1,50	2079
27,5x2,1	2148
27,5x2,25	2182
700x18C	2070
700x19C	2080
700x20C	2086
700x23C	2096
700x25C	2105
700x28C	2136
700x30C	2146
700x32C	2155
700C Tubular	2130
700x35C	2168
700x38C	2180
700x40C	2200
700x42C	2224
700x44C	2235
700x45C	2242
700x47C	2268
29x2,1	2288
29x2,2	2298
29x2,3	2326

Data Field

Category	Data Field	Description of Data Fields
Altitude	Altitude	The height of your current location above or below sea level.
	Max Altitude	The highest height of your current location above or below sea level which the rider achieved for the current activity.
	Alt. Gain	The total altitude distance gained during this current activity.
	Alt. Loss	The total altitude lost during this current activity.
	Grade	The calculation of altitude over distance.
	Uphill Dist.	The total distance traveled while ascending.
	Downhill Dist.	The total distance traveled while descending.
	Alt. Gain(lap)	The total altitude distance gained during the current lap.
	Alt. Loss(lap)	The total altitude lost during the current lap.
	Avg Grade(lap)	The average gradient for the current lap.
Distance	Distance	The distance traveled for current activity.
	ODO	The accumulated total distance until you reset it.
	LapDistance	The distance traveled for the current lap.
	LLapDist.	The distance traveled for the last finished lap.
	Trip 1/Trip 2	Cumulative mileage recorded before you reset it. They are 2 separate trip measurements. You are free to use Trip 1 or Trip 2 to record, for example, weekly total distance and use another to record, for example, monthly total distance.
Speed	Speed	The current rate of change in distance.
	Avg Speed	The average speed for current activity.
	Max Speed	The maximum speed for current activity.
	LapAvgSpd	The average speed for the current lap.
	LapMaxSpd	The maximum speed for the current lap.
	LLapAvgSpd	The average speed for the last finished lap.
Cadence	Cadence	The current rate at which rider is pedalling the pedals.
	Avg CAD	The average cadence for current activity.
	Max CAD	The maximum cadence for current activity.
	LapAvgCad	The average cadence for the current lap.
	LLapAvCad	The average cadence for the last finished lap.

Category	Data Field	Description of Data Fields
Time	Time	Current GPS Time.
	Ride Time	The time spent on riding for current activity.
	Trip Time	Total time spent for current activity.
	Sunrise	The time of sunrise based on your GPS location.
	Sunset	The time of sunset based on your GPS location.
	LapTime	The stopwatch time for the current lap.
	LLapTime	The stopwatch time for the last finished lap.
	Lap Count	The number of laps finished for the current activity.
Energy	Calories	The number of total calories burned.
	Kilojoules	The accumulated power output in kilojoules for the current activity.
Heart Rate	Heart Rate	The number of times your heart beats per minute. It requires compatible HR sensor pairing connection to your device.
	Avg HR	The average heart rate for current activity.
	Max HR	The maximum heart rate for current activity.
	MHR %	Your current heart rate divided by Maximum Heart Rate. MHR means that the maximum number of beats made by your heart in 1 minute of effort. (MHR is different from Max HR. You will need to set MHR in User Profile)
	LTHR%	Your current heart rate divided by Lactate Threshold Heart Rate. LTHR means that the average heart rate while in the intense exercise at which the blood concentration of lactate begins to exponentially increase. (You will need to set LTHR in User Profile)
	HR Zone	The current range of your Heart Rate (Zone 1 to Zone 7).
	MHR Zone	The current range of your Maximum Heart Rate Percentage heart rate (Zone 1 to Zone 75).
	LTHR Zone	The current range of your Lactate Threshold Heart Rate Percentage (Zone 1 to Zone 7).
	LapAvgHR	The average heart rate for the current lap.
	LLapAvgHR	The average heart rate for the last finished lap.
	Lap MHR%	The average of MHR% for the current lap.
Lap LTHR%	The average of LTHR% for the current lap.	
Time in zone	The time you reach the value of the different zones.	

Category	Data Field	Description of Data Fields
Power	Power Now	Current Power in Watt.
	Avg Power	The average power for the current activity.
	Max Power	The maximum power for the current activity.
	LapAvgPw	The average power for the current lap.
	LapMaxPw	The maximum power for the current lap.
	3s power	3 seconds average of power
	10s power	10 seconds average of power
	30s power	30 seconds average of power
	NP (Normalized Power)	An estimate of the power that you could have maintained for the same physiological “cost” if your power had been perfectly constant, such as on an ergometer, instead of variable power output.
	w/kg	Power to weight ratio
	TSS (Training Stress Score)	Training Stress Score is calculated by taking into account both the intensity such as IF and the duration of the ride. A way of measuring how much stress is put on the body from a ride.
	IF (Intensity Factor)	Intensity Factor is the ratio of the normalized power(NP) to your Functional Threshold Power(FTP). An indication of how hard or difficult a ride was in relation to your overall fitness.
	FTP Zone	The current range of your Functional Threshold Power Percentage (Zone1 to Zone 7).
	MAP Zone	The current range of your Maximum Aerobic Power Percentage (Zone 1 to Zone 7).
	MAP%	The current power divided by your Maximum Aerobic Power.
	FTP%	The current power divided by your functional threshold power.
	Lap NP	Normalized power of the current lap
	LLapAvgPw	The average power output for the last finished lap.
	LlapMaxPw	The maximum power for the last finished lap.
	Left Power	The Left-side power meter value.
Right Power	The Right-side power meter value.	
Heading	Heading	Heading function informs you which direction you are currently heading.
Temperature	Temp	The current temperature.

Category	Data Field	Description of Data Fields
Pedal Analysis	CurPB-LR	The current left/right power balance.
	AvgPB-LR	The average left/right power balance for the current activity.
	CurTE-LR	The current left/right percentage of how efficiently a rider is pedaling.
	MaxTE-LR	The maximum left/right percentage of how efficiently a rider is pedaling.
	AvgTE-LR	The average left/right percentage of how efficiently a rider is pedaling.
	CurPS-LR	The current left/right percentage of how evenly a rider is applying force to the pedals throughout each pedal stroke.
	MaxPS-LR	The maximum left/right percentage of how evenly a rider is applying force to the pedals throughout each pedal stroke.
	AvgPS-LR	The average left/right percentage of how evenly a rider is applying force to the pedals throughout each pedal stroke.
Workout	Target power	You can set a power target for your workout plan.
	Target cadence	You can set a cadence target for your workout plan.
	Target heartrate	You can set a target of heart rate zone for your workout plan.
	Remaining step time	The remaining distance of the current training.
	Remaining workout time	The remaining duration of the current training.
	Interval count	The number of the intervals of your workout.
Route	Dist to POI	Distance to next point of interest.
	Dist to Peak	Distance to next peak.
	Turn Info	Inform the rider the information of every turn.
	Dist to Destination	The remaining distance to the destination.

Category	Data Field	Description of Data Fields
Graph	SPD Ring	The current speed rate displays in dynamic coloured graphical mode.
	SPD Bar	
	CAD Ring	The current cadence rate displays in dynamic coloured graphical mode.
	CAD Bar	
	HR Ring	The current heart rate displays in dynamic coloured graphical mode.
	HR Bar	
	PW Ring	The current power rate displays in dynamic coloured graphical mode.
	PW Bar	
	3s PW Ring	3 seconds average of power displays in dynamic coloured graphical mode.
	10s PW Ring	10 seconds average of power displays in dynamic coloured graphical mode.
	30s PW Ring	30 seconds average of power displays in dynamic coloured graphical mode.
Ebike	Ebike Battery	The battery status of the conneted ebike.
	Travel Range	The possible distance that a rider could ride with the ebike.
	Assist Mode	Various modes provided by the ebike with assigned levels of assistance.
	Assist Level	The level of electronic assistance provided by the ebike in a given power mode.
	Ebike Rear Gear	The gear position of the rear derailleur of Ebike displayed by the graphic.
	Assist Mode & Level	The current ebike assist mode and level of electronic assistance.
Electronic Gear-Shifting Systems	ESS/Di2 Battery Level	The remaining battery power of the ESS/Di2 system.
	Front Gear	The gear position of the front derailleur displayed by the graphic.
	Rear Gear	The gear position of the rear derailleur displayed by the graphic.
	Gear Ratio	The ratio of the current teeth of the front gear to that of the rear gear.
	Gears	The front and rear bike gears position displayed by numbers.
	Gear Combo	The current gear combination of the front gear and the rear gear.

NOTE: Only supported for e-bike systems that support listed data.

Basic Care For Your Rider 460

Taking good care of your device will reduce the risk of damage to your device.

- Do not drop your device or subject it to severe shock.
- Do not expose your device to extreme temperatures and excessive moisture.
- The screen surface can easily be scratched. Use the non-adhesive generic screen protectors to help protect the screen from minor scratches.
- Use diluted neutral detergent on a soft cloth to clean your device.
- Do not attempt to disassemble, repair, or make any modification to your device. Any attempt to do so will make the warranty invalid.



RF Exposure Information (MPE)

This device meets the EU requirements and the International Commission on Non-Ionizing Radiation Protection (ICNIRP) on the limitation of exposure of the general public to electromagnetic fields by way of health protection. To comply with the RF exposure requirements, this equipment must be operated in a minimum of 20 cm separation distance to the user.

Hereby, Bryton Inc. declares that the radio equipment type Bryton product is in compliance with Directive 2014/53/EU. The full text of the EU declaration of conformity is available at the following internet address:

http://www.brytonsport.com/download/Docs/CeDocs_Rider460.pdf



Designed by Bryton Inc.

Copyright© 2024 Bryton Inc. All rights reserved.

3F-1, No.79-1, Zhouzi St., Neihu Dist., Taipei City 114, Taiwan (R.O.C.)

.)